

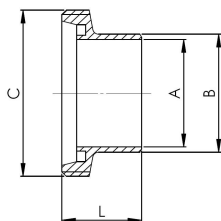

CANG ZHOU CHANGYUAN FITTINGS CO.,LTD

No.26 Shigang Road,Development Zone,Cangzhou,Hebei,China 061000 E-mail: Con-well@vip.163.com

DIN11851 UNIONS (Measures:mm)



DIN11851 Welding Male (Normal type,middle thickness)

Item \ DN	10	15	20	25	32	40	50	65	80	101.6	104	125	150
A	10	16	20	26	32	38	50	66	81	99	100	125	150
B	15	21	25	31	37	43	55	72	87	104	106	132	157
C(RD)	28	34	44	52	58	65	78	95	110	130	130	160	190
L	21	21	24	29	32	33	35	40	45	54	54	46	50

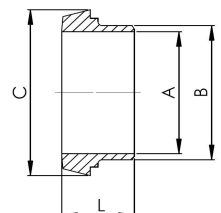

DIN11851 Welding Liner (Normal type,middle thickness)

Item \ DN	10	15	20	25	32	40	50	65	80	101.6	104	125	150
A	10	16	20	26	32	38	50	66	81	99	100	125	150
B	15	21	25	31	37	43	55	72	87	104	106	132	157
C	22	28	36	44	50	56	68	86	100	121	121	150	176
L	17	17	18	22	25	26	28	32	37	44	44	34	37

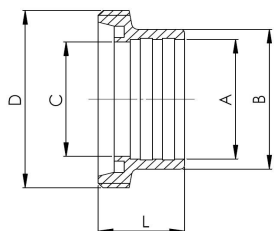

DIN11851 Welding Expanding Male

Item \ DN	10	15	20	25	32	40	50	60	65	80	101.6	104
A	12.2	18.2	22.2	28.2	34.2	40.2	52.2	60.5	70.3	85.3	101.9	104.3
B	18	24	30	35	41	48	61	69	79	93	112	114
C	10	16	20	26	32	38	50	57	66	81	99	100
D(RD)	28	34	44	52	58	65	78	84.5	95	110	130	130
L	21	21	24	29	32	33	35	36	40	45	54	54



CANG ZHOU CHANGYUAN FITTINGS CO.,LTD

No.26 Shigang Road,Development Zone,Cangzhou,Hebei,China 061000 E-mail: Con-well@vip.163.com

DIN11851 UNIONS (Measures:mm)

DIN11851 Welding Expanding Liner

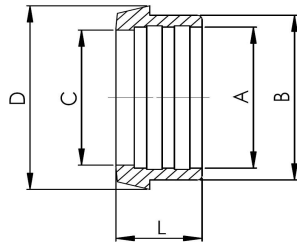

Item \ DN	10	15	20	25	32	40	50	60	65	80	101.6	104
A	12.2	18.2	22.2	28.2	34.2	40.2	52.2	60.5	70.3	85.3	101.9	104.3
B	18	24	30	35	41	48	61	69	79	93	112	114
C	10	16	20	26	32	38	50	57	66	81	99	100
D	22	28	36	44	50	56	68	76	86	100	121	121
L	17	17	18	22	25	26	28	31	32	37	44	44

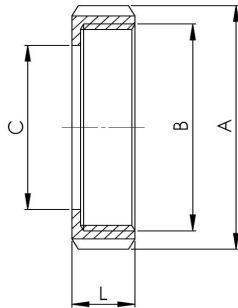

DIN11851 Round Nut

Item \ DN	10	15	20	25	32	40	50	60	65	75	80	104	125	150
A	38	44	54	63	70	78	92	99	112	120	127	148	178	210
B	28	34	44	52	58	65	78	85	95	104	110	130	160	190
C	19	25	31	36	42	49	62	70	80	88	94	115	138	164
L	18	18	20	21	21	21	22	24	25	26	29	31	35	40
slots	4	4	4	4	4	4	4	4	6	6	6	6	6	6

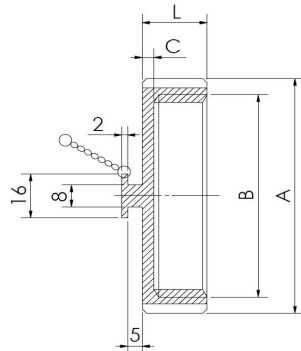

DIN11851 Blind Nut

Item \ DN	10	15	20	25	32	40	50	65	80	100	125	150
A	38	44	54	63	70	78	92	112	127	148	178	210
B	28	34	44	52	58	65	78	95	110	130	160	190
C	3	3	3	3	3	3	3	4	5	5	6	6
L	18	18	20	21	21	21	22	25	30	31	35	41
slots	4	4	4	4	4	4	4	6	6	6	6	6



CANG ZHOU CHANGYUAN FITTINGS CO.,LTD

No.26 Shigang Road,Development Zone,Cangzhou,Hebei,China 061000 E-mail: Con-well@vip.163.com

DIN11851 UNIONS (Measures:mm)

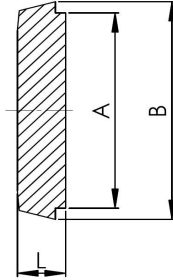

DIN11851 Blank Cap

Item \ DN	10	15	20	25	32	40	50	65	75	80	100	125	150
A	18	24	30	35	41	48	61	79	86	93	114	137	163
B	22	28	36	44	50	56	68	86	93	100	121	150	176
L	9	9	11	13	13	13	14	16	16	16	20	22	24

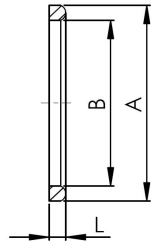

DIN11851 Seal(EPDM,Silion,Viton)

Item \ DN	10	15	20	25	32	40	50	65	80	100	125	150
A	20	26	33	40	46	52	64	81	95	114	142	167
B	12	18	23	30	36	42	54	71	85	104	130	155
L	4.5	4.5	4.5	5	5	5	5	5	5	6	7	7

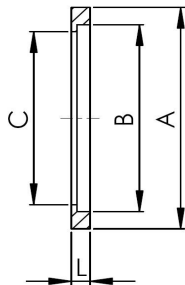

DIN11851 Seal(EPDM,Silion,Viton)

Item \ DN	10	15	20	25	32	40	50	65	80	100	125	150
A	20	26	33	40	46	52	64	81	95	114	142	167
B	12	18	23	30	36	42	54	71	85	104	130	155
C	10	16	20	26	32	38	50	66	81	100	125	150
L	4.5	4.5	4.5	5	5	5	5	5	5	6	7	7



Item	Size (DN)	D	C																			
				INCH type			ISO type			Light type I			Light type II			Normal type			Heavy type			
				Size	B-OD	A-ID	TK	B-OD	A-ID	TK	B-OD	A-ID	TK	B-OD	A-ID	TK	B-OD	A-ID	TK	B-OD	A-ID	TK
1	10	28	21	1/2"	12.7	9.7	1.5	17.6	14.4	1.6	12	9	1.5	13	10	1.5	15	10	2.5	18	10	4
2	15	34	21	3/4"	19.05	16.05	1.5	21.3	18.1	1.6	18	15	1.5	19	16	1.5	21	16	2.5	24	16	4
3	20	44	24	/	/	/	/	26.9	23.7	1.6	22	19	1.5	23	20	1.5	25	20	2.5	30	20	5
4	25	52	29	1"	25.4	22.2	1.6	33.7	29.7	2	28	25	1.5	29	26	1.5	31	26	2.5	35	26	4.5
5	32	58	32	/	/	/	/	42.4	38.4	2	34	31	1.5	35	32	1.5	37	32	2.5	41	32	4.5
6	40	65	33	1 1/2"	38.1	34.9	1.6	48.3	44.3	2	40	37	1.5	41	38	1.5	43	38	2.5	48	38	5
7	50	78	35	2"	50.8	47.6	1.6	60.3	56.3	2	52	49	1.5	53	50	1.5	55	50	2.5	61	50	5.5
8	60	84.5	36	/	/	/	/	/	/	/	/	/	/	/	/	/	/	/	/	69	57	6
9	65	95	40	2 1/2"	63.5	60.3	1.6	76.1	72.1	2	70	66	2	70	66	2	72	66	3	79	66	6.5
10	75	104	40	3"small	76.2	73	1.6	/	/	/	/	/	/	/	/	/	/	/	/	/	/	/
11	80	110	45	3"big	76.2	73	1.6	88.9	84.9	2	85	81	2	85	81	2	87	81	3	93	81	6
12	101.6	130	54	4"	101.6	97.6	2	/	/	/	101.6	97.6	2	101.6	97.6	2	104	99	2.5	/	/	/
13	104	130	54	/	/	/	/	114.3	109.1	2.6	104	100	2	104	100	2	106	100	3	114	100	7
14	125	160	46	5"	127	123	2	/	/	/	129	125	2	129	125	2	132	125	3.5	/	/	/
15	150	190	50	6"	152.4	148.4	2	/	/	/	154	150	2	154	150	2	157	150	3.5	/	/	/



Item	Size (DN)	D	C																			
				INCH type			ISO type			Light type I			Light type II			Normal type			Heavy type			
				Size	B-OD	A-ID	TK	B-OD	A-ID	TK	B-OD	A-ID	TK	B-OD	A-ID	TK	B-OD	A-ID	TK	B-OD	A-ID	TK
1	10	22	17	1/2"	12.7	9.7	1.5	17.6	14.4	1.6	12	9	1.5	13	10	1.5	15	10	2.5	18	10	4
2	15	28	17	3/4"	19.05	16.05	1.5	21.3	18.1	1.6	18	15	1.5	19	16	1.5	21	16	2.5	24	16	4
3	20	36	18	/	/	/	/	26.9	23.7	1.6	22	19	1.5	23	20	1.5	25	20	2.5	30	20	5
4	25	44	22	1"	25.4	22.2	1.6	33.7	29.7	2	28	25	1.5	29	26	1.5	31	26	2.5	35	26	4.5
5	32	50	25	/	/	/	/	42	38.4	1.8	34	31	1.5	35	32	1.5	37	32	2.5	41	32	4.5
6	40	56	26	1 1/2"	38.1	34.9	1.6	48.3	44.3	2	40	37	1.5	41	38	1.5	43	38	2.5	48	38	5
7	50	68	28	2"	50.8	47.6	1.6	60.3	56.3	2	52	49	1.5	53	50	1.5	55	50	2.5	61	50	5.5
8	60	76	31	/	/	/	/	/	/	/	/	/	/	/	/	/	/	/	/	69	57	6
9	65	86	32	2 1/2"	63.5	60.3	1.6	76.1	72.1	2	70	66	2	70	66	2	72	66	3	79	66	6.5
10	75	93	32	3"small	76.2	73	1.6	/	/	/	/	/	/	/	/	/	/	/	/	/	/	/
11	80	100	37	3"big	76.2	73	1.6	88.9	84.9	2	85	81	2	85	81	2	87	81	3	93	81	6
12	101.6	121	44	4"	101.6	97.6	2	/	/	/	101.6	97.6	2	101.6	97.6	2	104	99	2.5	/	/	/
13	104	121	44	/	/	/	/	114.3	109.1	2.6	104	100	2	104	100	2	106	100	3	114	100	7
14	125	150	34	5"	127	123	2	/	/	/	129	125	2	129	125	2	132	125	3.5	/	/	/
15	150	176	37	6"	152.4	148.4	2	/	/	/	154	150	2	154	150	2	157	150	3.5	/	/	/