

Tube Hanger (Measures:mm)

**CY-TH1
管支架 Tubing Hanger**

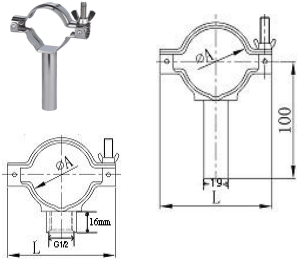

SIZE	A	L
1"	25.4	66
1.5"	38.1	79
2"	50.8	90
2.5"	63.5	105
3"	76.3	120
4"	101.6	146

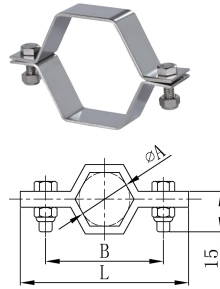

**CY-TH2
ISO-六角管支架 ISO-Hex Tubing Hangers**

SIZE	A	B	L
ISO21.3	21.3	48	68
ISO26.9	26.6	55	74
ISO33.7	33.7	63	82
ISO42.4	42.4	74	93
ISO48.3	48.3	82	101
ISO60.3	60.3	95	114
ISO88.9	88.9	130	149
ISO114.3	114.3	158	177

**CY-TH3
3A/SMS/DIN 六角管支架-Hex Tubing Hangers**

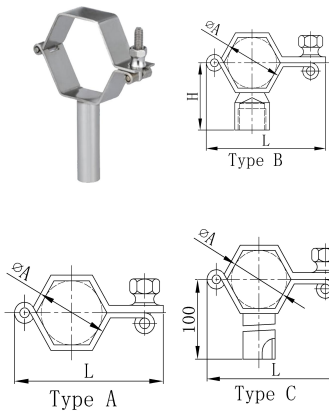

SIZE	A	L	H
SMS25	25	61	45
DIN28	28	64	46.5
DIN34	34	64	49.5
SMS38	38	76	51.5
DIN40	40	78	52.5
SMS51	51	90	58
DIN52	52	90	58.5
SMS63.5	63.5	106	64
DIN70	70	111	67.5
SMS76	76	120	70.5
DIN85	85	125	75
DIN101.6	101.6	146	83
SMS104	104	152	84.5

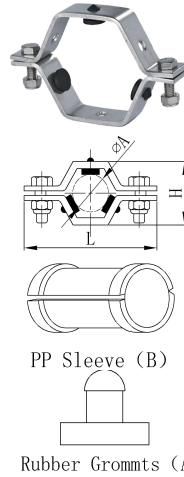

**CY-TH4
TH-4管支架PIPE Hanger**

SIZE	A	H	L
1"	25.4	42.4	86.6
1.5"	38.1	55.1	79
2"	50.8	67.8	92
2.5"	63.5	80.5	127.6
3"	76.2	93.2	142
4"	104	122	175
6"	152.4	174	235

**CY-TH5
DIN管支架 DIN Hanger**

SIZE	A	H	C
DN10	12/13	67.5	6
DN15	18/19	70.5	8
DN20	22/23	72.5	8
DN25	28/29	75.5	8
DN32	34/35	78.5/79.5	10
DN40	40/41	81.5/82.5	10
DN50	52/53	88/89	12
DN65	70	98	12
DN85	85	105.5	15
DN100	104	116	15
DN125	129	127	18
DN150	154	140	18
DN200	204		
DN250	254		

INCH管支架 INCH Hanger

SIZE	A	H	C
1"	25.5	84	10
1 1/4"	31.75	87	10
1 1/2"	38.1	90	10
2"	50.8	76	10
2 1/2"	63.5	85	10
3"	76.1	92.5	10
4"	101.6	102	10
5"	129	114.5	12
6"	154	127	12
8"	204	152	12

DIN管支架 DIN Hanger

SIZE	A	H	C
NW20	22	61	10
NW25	28	64	10
NW32	34	67	10
NW40	40	70	10
NW50	52	76	10
NW65	70	85	10
NW80	85	92.5	10
NW100	104	102	10
NW125	129	114.5	12
NW150	154	127	12
NW200	204	152	12

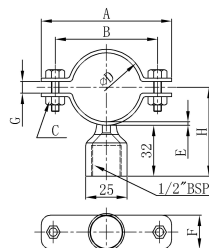
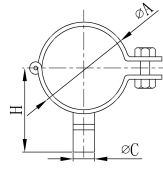

SIZE	D	A	B	C	E	F	G	H
1"	25.5	55	40	M6×P1.0×16L	2	20	3	46.8
1 1/4"	31.75	60	46	M6×P1.0×16L	2	20	4	49.9
1 1/2"	38.1	80	65	M6×P1.0×16L	2	25	4	53
2"	50.8	90	70	M6×P1.0×16L	2	30	5	59.4
2 1/2"	63.5	120	102	M6×P1.0×16L	2.5	30	5	66.3
3"	76.1	138	118	M8×P1.25×20L	2.5	30	5	72.6
4"	101.6	180	145	M8×P1.25×25L	2.5	30	8	85.3
5"	129	207	186	M8×P1.25×25L	2.5	30	8	99
6"	154	232	205	M10×P1.5×25L	3	30	8	112
8"	204	285	265	M10×P1.5×25L	3	30	8	137

Tubing Hanger (Measures:mm)

CY-TH6

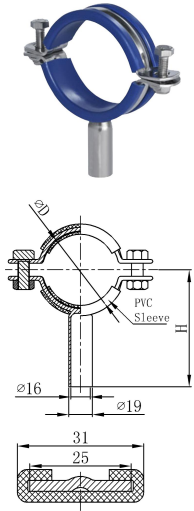

SIZE	D	H
1/2"	12.7	90
3/4"	19.1	90
1"	25.4	90
1 1/2"	38.1	90
2"	50.8	90
2 1/2"	63.5	90
3"	76.2	90
4"	101.6	90
5"	129	117.5
6"	154	130
8"	204	155
10"	254	180
12"	304	205

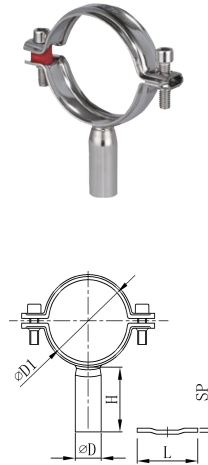

CY-007

SIZE	D	D1	L	H	SP
1/4"	8	6.2	12	47	1.5
1/2"	8	12.5	12	47	1.5
3/4"	19	19	25	47	1.5
1"	19	25.4	25	47	1.5
1.5"	19	38.1	25	47	1.5
2"	19	50.8	25	47	1.5
2.5"	19	63.5	25	47	2
3"	19	76.2	25	47	2
4"	19	101.6	28	47	2
5"	19	129	28	47	2.5
6"	19	154	28	47	2.5
8"	25	204	35	47	3
10"	25	254	35	47	3
12"	25	304	35	47	3

CY-008

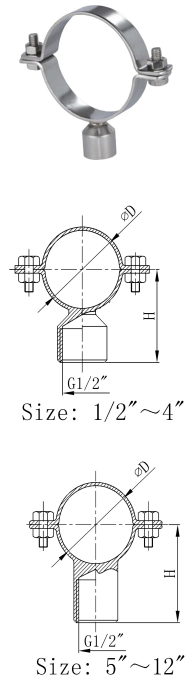

SIZE	D	H	SIZE	D	H
1/2"	12.7	35.85	5"	129	101.5
3/4"	19.1	39	6"	154	114
1/2"NB	21.3	40.15	6"NB	168	122
1"	25.4	42.2	8"	204	139
3/4"NB	26.7	42.85	10"	254	164
1 1/4"	32	45.5	12"	304.8	189
1"NB	33.4	46.2			
1 1/2"	38.1	48.55			
1 1/4"NB	42.2	50.6			
1 1/2"NB	48.3	53.65			
2"	50.8	55			
2"NB	60.3	59.65			
2 1/2"	63.5	62			
2 1/2"NB	73	66.5			
3"	76.2	68			
3"NB	89	74.5			
4"	102	82			
4"NB	114	88			

CY-009

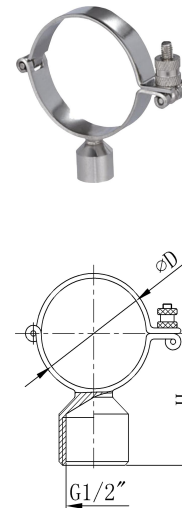

SIZE	D	H
1/2"	12.7	35.85
3/4"	19.1	39
1/2"NB	21.3	40.15
1"	25.4	42.2
3/4"NB	26.7	42.85
1 1/4"	32	45.5
1"NB	33.4	46.2
1 1/2"	38.1	48.55
1 1/4"NB	42.2	50.6
1 1/2"NB	48.3	53.65
2"	50.8	55
2"NB	60.3	59.65
2 1/2"	63.5	62
2 1/2"NB	73	66.5
3"	76.2	68
3"NB	89	74.5
4"	102	82
4"NB	114	88

CY-010

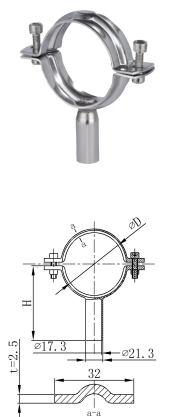

SIZE	D	H
1/2"	12.7	90
3/4"	19.1	90
1"	25.4	90
1 1/2"	38.1	90
2"	50.8	90
2 1/2"	63.5	90
3"	76.2	90
4"	101.6	90
5"	129	125
6"	154	135
8"	204	145
10"	254	174
12"	304	200

CY-011

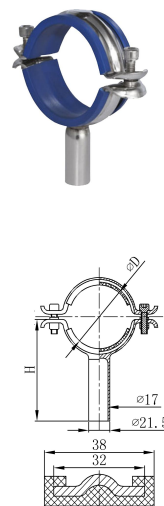

SIZE	D	H
1/2"	12.7	90
3/4"	19.1	90
1"	25.4	90
1 1/2"	38.1	90
2"	50.8	90
2 1/2"	63.5	90
3"	76.2	90
4"	101.6	90
5"	129	125
6"	154	135
8"	204	145
10"	254	174
12"	304	200

Tubing Hanger (Measures:mm)

CY-012

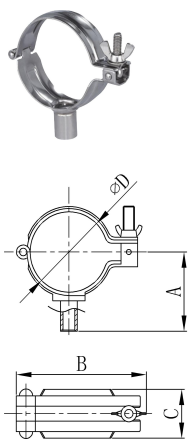

SIZE	D	A	B	C
1.0"	25.4	40.5	68	28
1.5"	38.1	47	81	28
2.0"	50.8	53.5	98	32
2.5"	63.5	60	112	32
3.0"	76.3	67.5	126	32
4.0"	101.6	80	154	32

CY-013—18400037

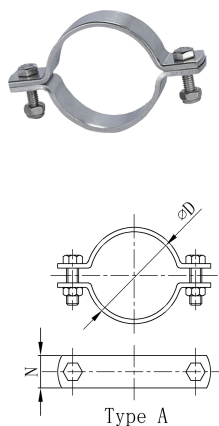

SIZE	D	N
DN10	13	20
DN15	19	20
DN20	23	20
DN25	29	20
DN32	35	20
DN40	41	20
DN50	53	20
DN65	70	20
DN80	85	25
DN100	104	25
DN125	129	30
DN150	154	40
DN200	204	50
DN250	254	60

18500055

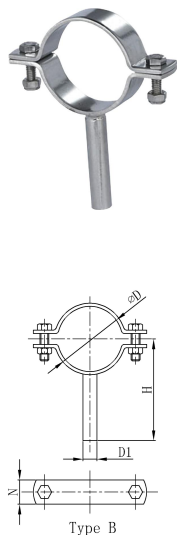

SIZE	D	D1	H	N
DN10	13	8	64	20
DN15	19	8	67	20
DN20	23	8	69	20
DN25	29	10	72	20
DN32	35	10	75	20
DN40	41	10	78	20
DN50	53	12	84	20
DN65	70	12	83	20
DN80	85	12	100	25
DN100	104	12	110	25
DN125	129	16	140	30
DN150	154	16	180	40
DN200	204	20	240	50
DN250	254	24	280	60

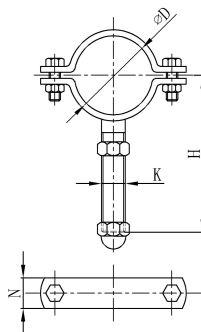

SIZE	D	K	H	N
DN10	13	M8	74	20
DN15	19	M8	77	20
DN20	23	M8	79	20
DN25	29	M10	102	20
DN32	35	M10	105	20
DN40	41	M10	108	20
DN50	53	M12	114	20
DN65	70	M12	123	20
DN80	85	M12	130.5	25
DN100	104	M12	140	25
DN125	129	M16	168.5	30
DN150	154	M16	202	40
DN200	204	M20	255	50
DN250	254	M22	295	60

CY-014

1424005

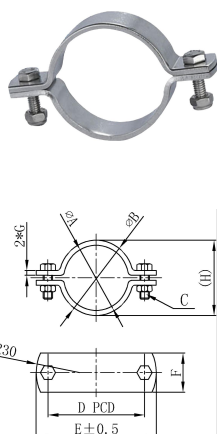

SIZE	A	B	C	D	E	F	G	H
DN10	12	18	M8*25L	35	55	30	3	18
DN15	18	24	M8*25L	45	65	30	3	24
DN20	22	28	M8*25L	50	70	30	3	28
DN25	28	34	M8*25L	55	75	30	3	34
DN32	34	40	M8*25L	60	80	30	3	40
DN40	40	46	M8*25L	65.5	85.5	30	3	46
DN50	52	58	M8*25L	80	100	30	3	58
DN65	70	76	M8*25L	100	120	30	3	76
DN80	85	91	M8*25L	115	135	30	3	91
DN100	104	110	M8*25L	135	155	30	3	110
DN125	129	137	M8*40L	174	200	30	4	137
DN150	154	164	M8*40L	214	240	40	5	164
DN200	204	214	M8*40L	264	294	40	5	214

Tubing Hanger (Measures:mm)

CY-014 1424006

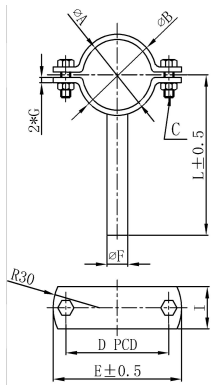

SIZE	A	B	C	D	E	F	G	I	L
DN10	12	18	M8*25L	35	55	8	3	30	64
DN15	18	24	M8*25L	45	65	8	3	30	67
DN20	22	28	M8*25L	50	70	8	3	30	69
DN25	28	34	M8*25L	55	75	10	3	30	72
DN32	34	40	M8*25L	60	80	10	3	30	75
DN40	40	46	M8*25L	65	85.5	10	3	30	78
DN50	52	58	M8*25L	80	100	14	3	30	84
DN65	70	76	M8*25L	100	120	14	3	30	93
DN80	85	91	M8*25L	115	135	16	3	30	100.5
DN100	104	110	M8*25L	135	155	16	3	30	110
DN125	129	137	M8*40L	174	200	20	4	30	140
DN150	154	164	M8*40L	214	240	20	5	40	180

CY-014 1424007

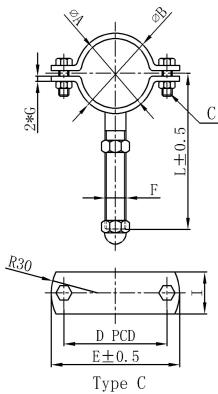

SIZE	A	B	C	D	E	F	G	I	L
DN10	12	18	M8*25L	35	55	M8	3	30	74
DN15	18	24	M8*25L	45	65	M8	3	30	77
DN20	22	28	M8*25L	50	70	M8	3	30	79
DN25	28	34	M8*25L	55	75	M10	3	30	102
DN32	34	40	M8*25L	60	80	M10	3	30	105
DN40	40	46	M8*25L	65.5	85.5	M10	3	30	108
DN50	52	58	M8*25L	80	100	M12	3	30	114
DN65	70	76	M8*25L	100	120	M12	3	30	123
DN80	85	91	M8*25L	115	135	M12	3	30	130.5
DN100	104	110	M8*25L	135	155	M12	3	30	140
DN125	129	137	M8*40L	174	200	M16	4	30	168.5
DN150	154	164	M8*40L	214	240	M16	5	40	202

CY-014 1424001

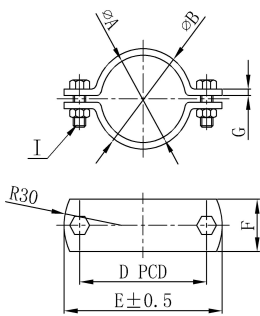

SIZE	A	B	D	E	G	F	I
0.5"	21.3	27.3	50	70	3	30	M8*25
0.75"	26.9	32.9	55	75	3	30	M8*25
1.0"	33.7	39.7	60	80	3	30	M8*25
1.25"	42.4	48.4	70	90	3	30	M8*25
1.5"	48.3	54.3	80	100	3	30	M8*25
2.0"	60.3	66.3	100	120	3	30	M8*25
2.5"	76.1	82.1	105	125	3	30	M8*25
3.0"	88.9	94.9	117.5	137	3	30	M8*25
4.0"	114.3	120.3	142.5	162	3	30	M8*25
5.0"	139.7	147.7	206	180	4	30	M8*30
6.0"	168.3	178.3	217	245	5	40	M8*35
8.0"	219.1	229.1	270	300	5	40	M8*40

CY-014 1424002

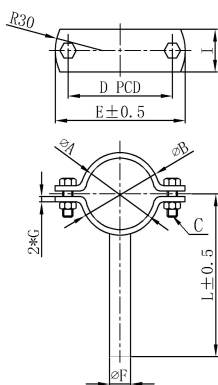

SIZE	A	B	C	D	E	F	G	I	L
0.5"	21.3	27.3	M8*25	50	70	10	3	30	72
0.75"	26.9	32.9	M8*25	55	75	10	3	30	72
1.0"	33.7	39.7	M8*25	60	80	10	3	30	75
1.25"	42.4	48.4	M8*25	70	90	10	3	30	79
1.5"	48.3	54.3	M8*25	80	100	10	3	30	82
2.0"	60.3	66.3	M8*25	100	120	14	3	30	88
2.5"	76.1	82.1	M8*25	105	125	14	3	30	96
3.0"	88.9	94.9	M8*25	117.5	137	16	3	30	103
4.0"	114.3	120.3	M8*25	142.5	162	16	3	30	115
5.0"	139.7	147.7	M8*30	206	180	20	4	30	150
6.0"	168.3	178.3	M8*35	217	245	20	5	40	180
8.0"	219.1	229.1	M8*40	270	300	20	5	40	240

Tubing Hanger (Measures:mm)

CY-014 1524006

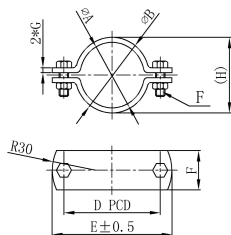

SIZE	A	B	D	E	H	G	I	F
1"	25.4	31.4	55	75	31.4	3	30	M8×30L
1.25"	31.8	37.8	60	80	37.8	3	30	M8×30L
1.5"	38.1	44.1	65.5	85.5	44.1	3	30	M8×30L
2.0"	50.8	56.8	80	100	56.8	3	30	M8×30L
2.5"	63.5	69.5	100	120	69.5	3	30	M8×30L
3.0"	76.2	82.2	115	135	82.2	3	30	M8×30L
4.0"	101.6	107.6	135	155	107.6	3	30	M8×30L
6.0"	152.4	162.4	214	240	162.4	5	40	M8×40L

CY-014 1524007

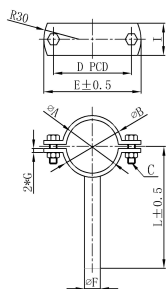

SIZE	A	B	C	D	E	F	L	G	I
1"	25.4	31.4	M8×30L	55	75	10	71	3	30
1.25"	31.8	37.8	M8×30L	60	80	10	77	3	30
1.5"	38.1	44.1	M8×30L	65.5	85.5	12	77	3	30
2.0"	50.8	56.8	M8×30L	80	100	14	84	3	30
2.5"	63.5	69.5	M8×30L	100	120	14	90	3	30
3.0"	76.2	82.2	M8×30L	115	135	14	96	3	30
4.0"	101.6	107.6	M8×30L	135	155	16	109	3	30
6.0"	152.4	162.4	M8×40L	214	240	20	182	5	40

CY-015

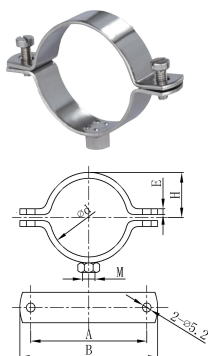

SIZE	d	M	A	B	E	H
3/8"	17.2	M8	39	57	2	9.5
1/2"	21.3	M8	43.5	61.5	2	10
3/4"	26.9	M8	49	67	2	13
1"	33.7	M8	57	75	2.5	17
1 1/4"	42.4	M8	67.5	87.5	2.5	21
1 1/2"	48.3	M8	73.5	93.5	2.5	24
2"	60.3	M8	85.5	105.5	2.5	30
2 1/2"	76.1	M10	106	131	2.5	37
3"	88.9	M10	119	144	2.5	43
4"	114.3	M10	145	170	3	56